

DETTAGLIO
SCALA 1 : 2

DETTAGLIO
SCALA 1 : 10

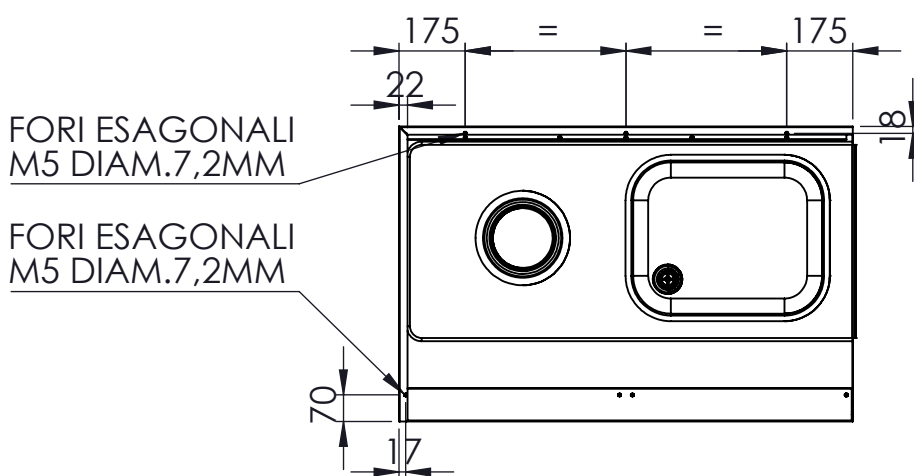
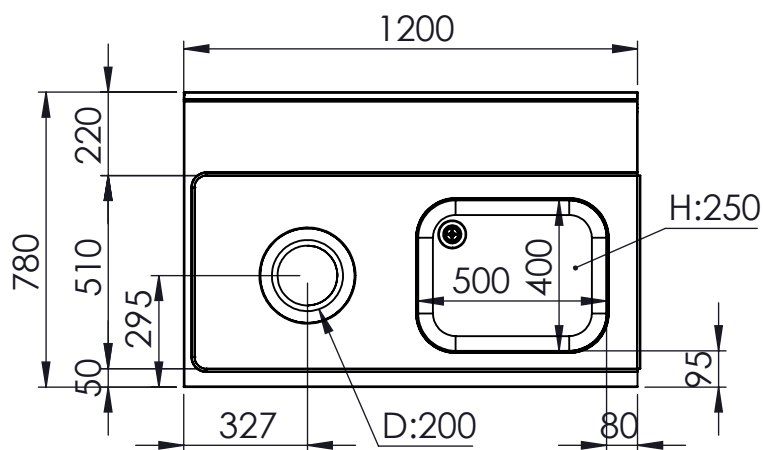

FORI ESAGONALI
M5 DIAM.7,2MM

FORI ESAGONALI
M5 DIAM.7,2MM

DISEGNATO	
DATA	18/01/2024
PESO	19372.09

CODICE: **MS00**



CONFIGURAZIONE: **L:1200 P:780**

SCALA: 1:20

A4

FOGLIO 1 DI 1